

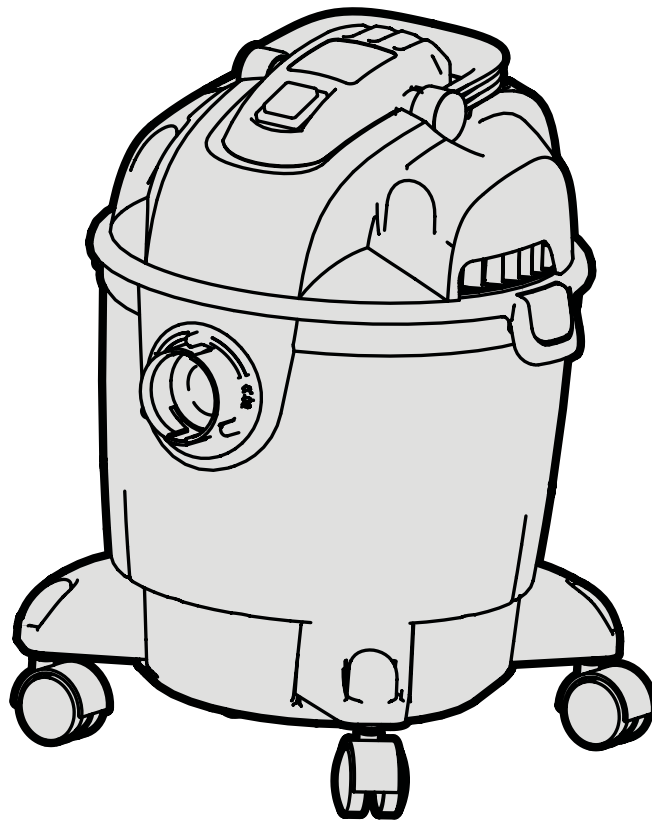

**MODEL VC4710**

# ***PORTABLE WET/DRY UTILITY VACUUM***

**Instruction Manual**



## ***NEED HELP? CONTACT US!***

Have product questions? Need technical support? Please feel free to contact us:



**1-800-232-1195 (M-F 8AM-5PM CST)**



**TECHSUPPORT@WENPRODUCTS.COM**

**IMPORTANT:** Your new tool has been engineered and manufactured to WEN's highest standards for dependability, ease of operation, and operator safety. When properly cared for, this product will supply you years of rugged, trouble-free performance. Pay close attention to the rules for safe operation, warnings, and cautions. If you use your tool properly and for its intended purpose, you will enjoy years of safe, reliable service.

For replacement parts and the most up-to-date instruction manuals, visit ***WENPRODUCTS.COM***

# CONTENTS

<b>WELCOME</b>	<b>3</b>
Introduction .....	3
Specifications.....	3
<b>SAFETY</b>	<b>4</b>
General Safety Rules.....	4
Wet/Dry Utility Vacuum Safety Warnings.....	6
Electrical Safety Warnings.....	7
<b>BEFORE OPERATING</b>	<b>8</b>
Unpacking & Packing List.....	8
Know Your Wet/Dry Utility Vacuum .....	9
Assembly & Adjustments.....	10
<b>OPERATION &amp; MAINTENANCE</b>	<b>11</b>
Operation .....	11
Maintenance.....	12
Troubleshooting Guide .....	13
Exploded View & Parts List.....	14
Warranty Statement .....	16

## **INTRODUCTION**

Thanks for purchasing the WEN Wet/Dry Utility Vacuum. We know you are excited to put your tool to work, but first, please take a moment to read through the manual. Safe operation of this tool requires that you read and understand this operator's manual and all the labels affixed to the tool. This manual provides information regarding potential safety concerns, as well as helpful assembly and operating instructions for your tool.

 **SAFETY ALERT SYMBOL:** Indicates danger, warning, or caution. The safety symbols and the explanations with them deserve your careful attention and understanding. Always follow the safety precautions to reduce the risk of fire, electric shock or personal injury. However, please note that these instructions and warnings are not substitutes for proper accident prevention measures.

**NOTE:** The following safety information is not meant to cover all possible conditions and situations that may occur. WEN reserves the right to change this product and specifications at any time without prior notice.

At WEN, we are continuously improving our products. If you find that your tool does not exactly match this manual, please visit [wenproducts.com](http://wenproducts.com) for the most up-to-date manual or contact our customer service at **1-800-232-1195**.

**Keep this manual available to all users during the entire life of the tool and review it frequently to maximize safety for both yourself and others.**

## **SPECIFICATIONS**

Model Number	VC4710
Motor	1200W, 120V, 60 Hz
Dust Capacity	5 Gallons
Filter Rating	HEPA F9
Product Dimensions	13.3 in. x 13.6 in. x 17.9 in.
Product Weight	11 Pounds

# GENERAL SAFETY RULES

 **WARNING!** Read all safety warnings and all instructions. Failure to follow the warnings and instructions may result in electric shock, fire and/or serious injury.

Safety is a combination of common sense, staying alert and knowing how your item works. The term “power tool” in the warnings refers to your mains-operated (corded) power tool or battery-operated (cordless) power tool.

## SAVE THESE SAFETY INSTRUCTIONS.

### WORK AREA SAFETY

- 1. Keep work area clean and well lit.** Cluttered or dark areas invite accidents.
- 2. Do not operate power tools in explosive atmospheres, such as in the presence of flammable liquids, gases or dust.** Power tools create sparks which may ignite the dust or fumes.
- 3. Keep children and bystanders away while operating a power tool.** Distractions can cause you to lose control.

### ELECTRICAL SAFETY

- 1. Power tool plugs must match the outlet. Never modify the plug in any way. Do not use any adapter plugs with earthed (grounded) power tools.** Unmodified plugs and matching outlets will reduce risk of electric shock.
- 2. Avoid body contact with earthed or grounded surfaces such as pipes, radiators, ranges and refrigerators.** There is an increased risk of electric shock if your body is earthed or grounded.
- 3. Do not expose power tools to rain or wet conditions.** Water entering a power tool will increase the risk of electric shock.
- 4. Do not abuse the cord. Never use the cord for carrying, pulling or unplugging the power tool. Keep cord away from heat, oil, sharp edges or moving parts.** Damaged or entangled cords increase the risk of electric shock.
- 5. When operating a power tool outdoors, use an extension cord suitable for outdoor use.** Use of a cord suitable for outdoor use reduces the risk of electric shock.

**6. If operating a power tool in a damp location is unavoidable, use a ground fault circuit interrupter (GFCI) protected supply.** Use of a GFCI reduces the risk of electric shock.

### PERSONAL SAFETY

- 1. Stay alert, watch what you are doing and use common sense when operating a power tool. Do not use a power tool while you are tired or under the influence of drugs, alcohol or medication.** A moment of inattention while operating power tools may result in serious personal injury.
- 2. Use personal protective equipment. Always wear eye protection.** Protective equipment such as a respiratory mask, non-skid safety shoes and hearing protection used for appropriate conditions will reduce the risk of personal injury.
- 3. Prevent unintentional starting. Ensure the switch is in the off-position before connecting to power source and/or battery pack, picking up or carrying the tool.** Carrying power tools with your finger on the switch or energizing power tools that have the switch on invites accidents.
- 4. Remove any adjusting key or wrench before turning the power tool on.** A wrench or a key left attached to a rotating part of the power tool may result in personal injury.
- 5. Do not overreach. Keep proper footing and balance at all times.** This enables better control of the power tool in unexpected situations.
- 6. Dress properly. Do not wear loose clothing or jewelry. Keep your hair and clothing away from moving parts.** Loose clothes, jewelry or long hair can be caught in moving parts.

# GENERAL SAFETY RULES

 **WARNING!** Read all safety warnings and all instructions. Failure to follow the warnings and instructions may result in electric shock, fire and/or serious injury.

Safety is a combination of common sense, staying alert and knowing how your item works. The term “power tool” in the warnings refers to your mains-operated (corded) power tool or battery-operated (cordless) power tool.

## SAVE THESE SAFETY INSTRUCTIONS.

**7. If devices are provided for the connection of dust extraction and collection facilities, ensure these are connected and properly used.** Use of dust collection can reduce dust-related hazards.

### POWER TOOL USE AND CARE

**1. Do not force the power tool. Use the correct power tool for your application.** The correct power tool will do the job better and safer at the rate for which it was designed.

**2. Do not use the power tool if the switch does not turn it on and off.** Any power tool that cannot be controlled with the switch is dangerous and must be repaired.

**3. Disconnect the plug from the power source and/or the battery pack from the power tool before making any adjustments, changing accessories, or storing power tools.** Such preventive safety measures reduce the risk of starting the power tool accidentally.

**4. Store idle power tools out of the reach of children and do not allow persons unfamiliar with the power tool or these instructions to operate the power tool.** Power tools are dangerous in the hands of untrained users.

**5. Maintain power tools. Check for misalignment or binding of moving parts, breakage of parts and any other condition that may affect the power tool's operation. If damaged, have the power tool repaired before use.** Many accidents are caused by poorly maintained power tools.

**6. Keep cutting tools sharp and clean.** Properly maintained cutting tools with sharp cutting edges are less likely to bind and are easier to control.

**7. Use the power tool, accessories and tool bits, etc. in accordance with these instructions, taking into account the working conditions and the work to be performed.** Use of the power tool for operations different from those intended could result in a hazardous situation.

**8. Use clamps to secure your workpiece to a stable surface.** Holding a workpiece by hand or using your body to support it may lead to loss of control.

**9. KEEP GUARDS IN PLACE** and in working order.

### SERVICE

**1. Have your power tool serviced by a qualified repair person using only identical replacement parts.** This will ensure that the safety of the power tool is maintained.

### CALIFORNIA PROPOSITION 65 WARNING

Some dust created by power sanding, sawing, grinding, drilling, and other construction activities may contain chemicals, including lead, known to the State of California to cause cancer, birth defects, or other reproductive harm. Wash hands after handling. Some examples of these chemicals are:

- Lead from lead-based paints.
- Crystalline silica from bricks, cement, and other masonry products.
- Arsenic and chromium from chemically treated lumber.

Your risk from these exposures varies depending on how often you do this type of work. To reduce your exposure to these chemicals, work in a well-ventilated area with approved safety equipment such as dust masks specially designed to filter out microscopic particles.

## **WET/DRY UTILITY VACUUM SAFETY WARNINGS**

 **WARNING!** Do not operate the power tool until you have read and understood the following instructions and the warning labels.

### **WET/DRY UTILITY VACUUM SAFETY**

1. Never operate this unit with flammable materials or vapors are present. This unit can produce sparks or arcs due to static electricity that can cause fire or explosions.
2. Do not use this vacuum to collect lead paint debris. Doing so may disperse fine lead particles into the environment. This vacuum is not intended for use under EPA Regulation 40 CFR Part 745 for lead paint material cleanup.
3. Do not use this vacuum to collect carcinogenic, combustible, toxic, or other hazardous materials.
4. Do not collect anything that is burning or smoking with this vacuum. This includes but is not limited to cigarettes, matches, or hot ashes.
5. Always use vacuum with filter in place.
6. Always wear safety glasses when operating the vacuum to avoid particles being blown into eyes.

# ELECTRICAL INFORMATION

## GROUNDING INSTRUCTIONS

In the event of a malfunction or breakdown, grounding provides the path of least resistance for an electric current and reduces the risk of electric shock. This tool is equipped with an electric cord that has an equipment grounding conductor and a grounding plug. The plug MUST be plugged into a matching outlet that is properly installed and grounded in accordance with ALL local codes and ordinances.

**1. Do not modify the plug provided.** If it will not fit the outlet, have the proper outlet installed by a licensed electrician.

**2. Improper connection** of the equipment grounding conductor can result in electric shock. The conductor with the green insulation (with or without yellow stripes) is the equipment grounding conductor. If repair or replacement of the electric cord or plug is necessary, DO NOT connect the equipment grounding conductor to a live terminal.

**3. Check** with a licensed electrician or service personnel if you do not completely understand the grounding instructions or whether the tool is properly grounded.

**4. Use only three-wire extension cords** that have three-pronged plugs and outlets that accept the tool's plug. Repair or replace a damaged or worn cord immediately.

**CAUTION!** In all cases, make certain the outlet in question is properly grounded. If you are not sure, have a licensed electrician check the outlet.

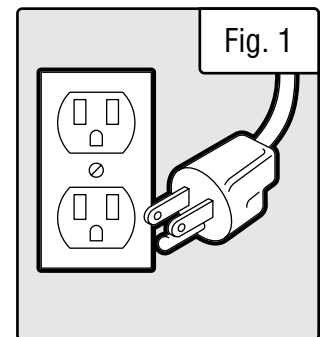

## GUIDELINES AND RECOMMENDATIONS FOR EXTENSION CORDS

When using an extension cord, be sure to use one heavy enough to carry the current your product will draw. An undersized cord will cause a drop in line voltage resulting in loss of power and overheating. The table below shows the correct size to be used according to cord length and ampere rating. When in doubt, use a heavier cord. The smaller the gauge number, the heavier the cord.

AMPERAGE	REQUIRED GAUGE FOR EXTENSION CORDS			
	25 ft.	50 ft.	100 ft.	150 ft.
10A	18 gauge	16 gauge	16 gauge	14 gauge

**1. Examine extension cord before use.** Make sure your extension cord is properly wired and in good condition. Always replace a damaged extension cord or have it repaired by a qualified person before using it.

**2. Do not abuse extension cord.** Do not pull on cord to disconnect from receptacle; always disconnect by pulling on plug. Disconnect the extension cord from the receptacle before disconnecting the product from the extension cord. Protect your extension cords from sharp objects, excessive heat and damp/wet areas.

**3. Use a separate electrical circuit for your tool.** This circuit must not be less than a 12-gauge wire and should be protected with a 15A time-delayed fuse. Before connecting the motor to the power line, make sure the switch is in the OFF position and the electric current is rated the same as the current stamped on the motor nameplate. Running at a lower voltage will damage the motor.

# UNPACKING & PACKING LIST

## UNPACKING

With the help of a friend or trustworthy foe, such as one of your in-laws, carefully remove the vacuum from the packaging and place it on a sturdy, flat surface. Make sure to take out all contents and accessories. Do not discard the packaging until everything is removed. Check the packing list below to make sure you have all of the parts and accessories. If any part is missing or broken, please contact customer service at **1-800-232-1195** (M-F 8-5 CST), or email [techsupport@wenproducts.com](mailto:techsupport@wenproducts.com).

## PACKING LIST

### Components

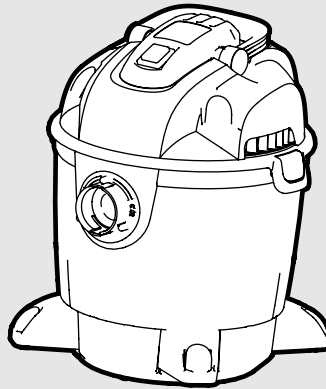

**Vacuum**

### Hardware & Accessories

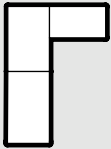

**Storage Hook**



**ST3.9x14 Screws (4)**

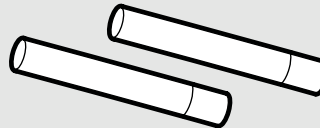

**Extension Tubes (2)**

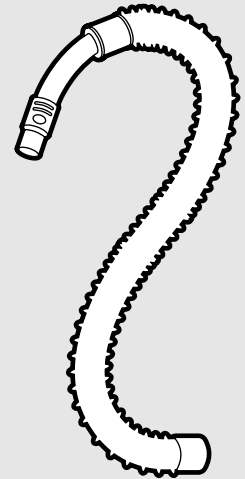

**Hose**

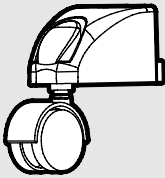

**Wheel Assembly (4)**

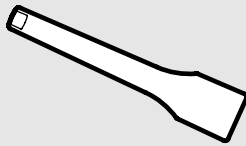

**Crevice Nozzle**

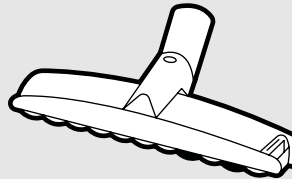

**Utility Nozzle**



# KNOW YOUR WET/DRY UTILITY VACUUM

## TOOL PURPOSE

From general garage spring cleaning to major basement cleanup from flooding or seepage, your wet/dry utility vacuum can handle it all. Refer to the following diagrams to become familiarized with all the parts and controls of your vacuum. The components will be referred to later in the manual for assembly and operation instructions.

## WET/DRY UTILITY VACUUM

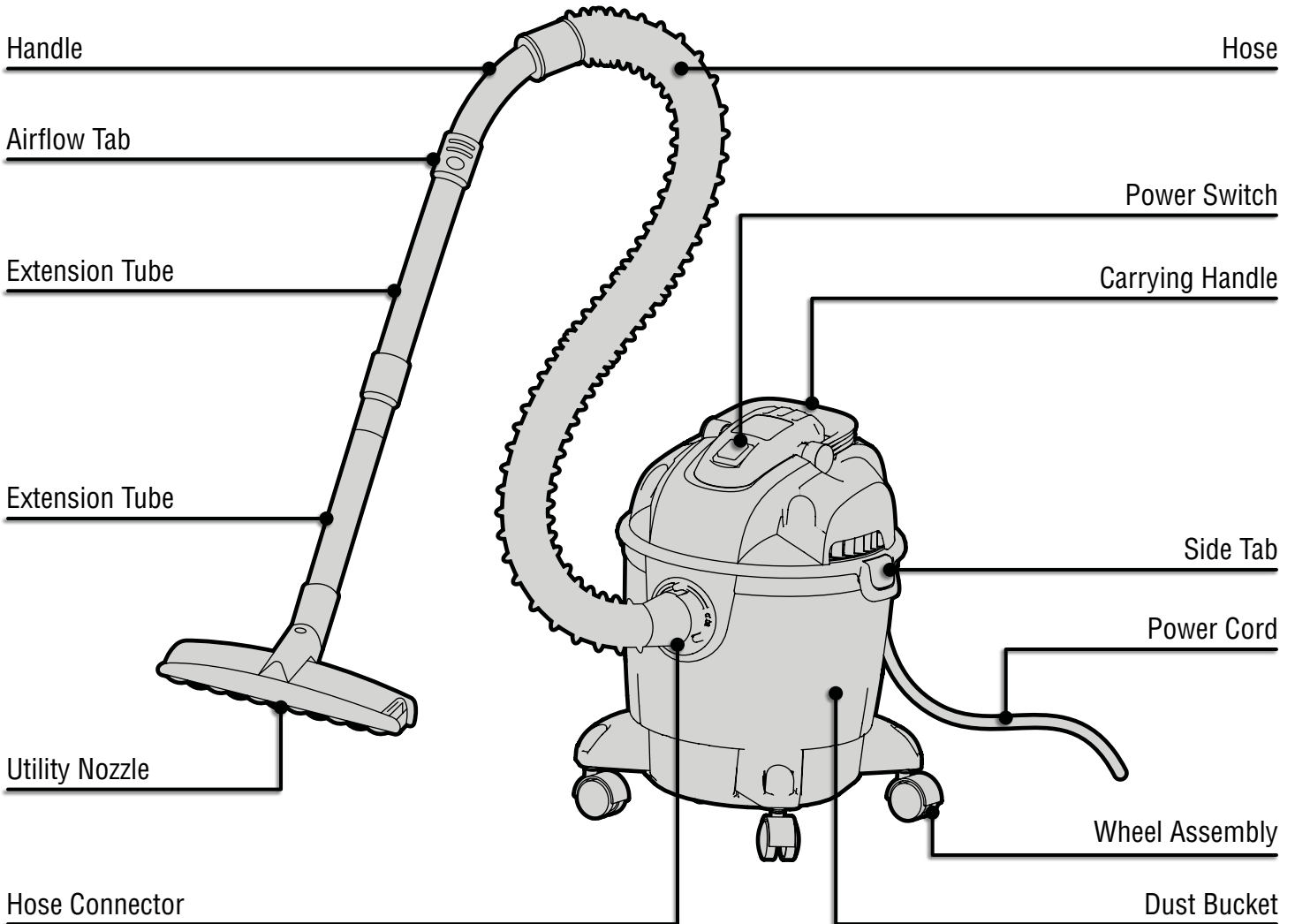

# ASSEMBLY & ADJUSTMENTS

## ASSEMBLING THE VACUUM

1. Ensure the unit is unplugged from its power source.
2. Pull out on the two side tabs (Fig. 1 - 1) and remove the top cover of the wet/dry vacuum (Fig. 1 - 2) to find the additional accessories inside the bucket (Fig. 1 - 3). Remove and set them aside.
3. Turn the bucket upside down and assemble the four wheel assemblies (Fig. 2 - 1) onto the bucket by inserting them into the proper slots on the bucket and securing each of them with a ST3.9x14 screw (Fig. 2 - 2).
4. Replace the top cover and attach the hose to either the suction inlet (Fig. 3a - 1) or blower outlet (Fig. 3b - 1) depending on your desired use. Lock the hose by inserting it into the respective port and twisting it about 1/8 turn clockwise. The suction / blow function can be changed easily by removing the hose and connecting it to the opposite port.
5. Extension tubes or accessories can be easily connected to the end of the handle by firmly pressing and firmly twisting the accessory to ensure a secure fit (Fig. 4a - Fig. 4c).

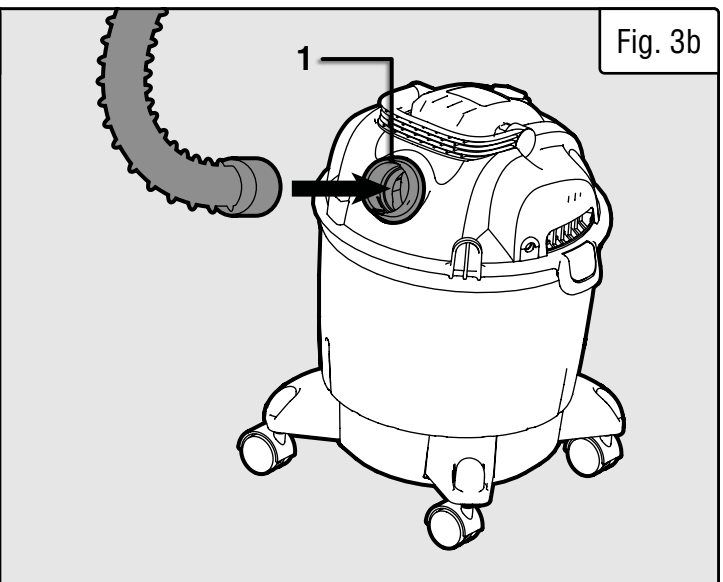
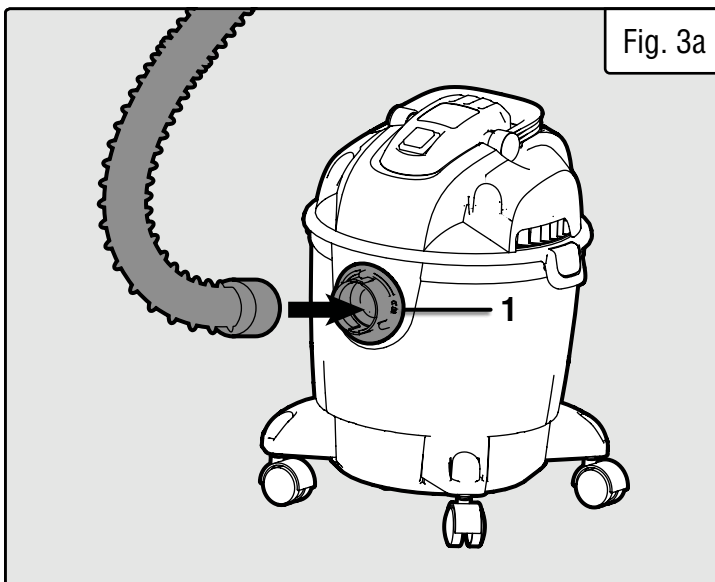
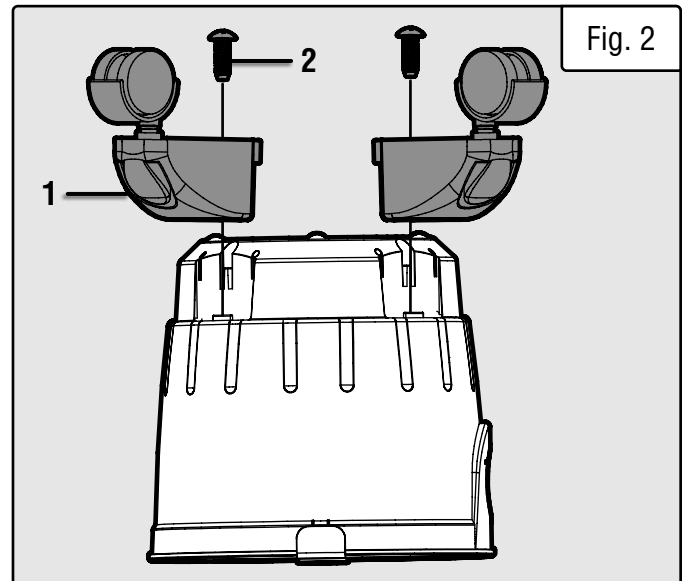
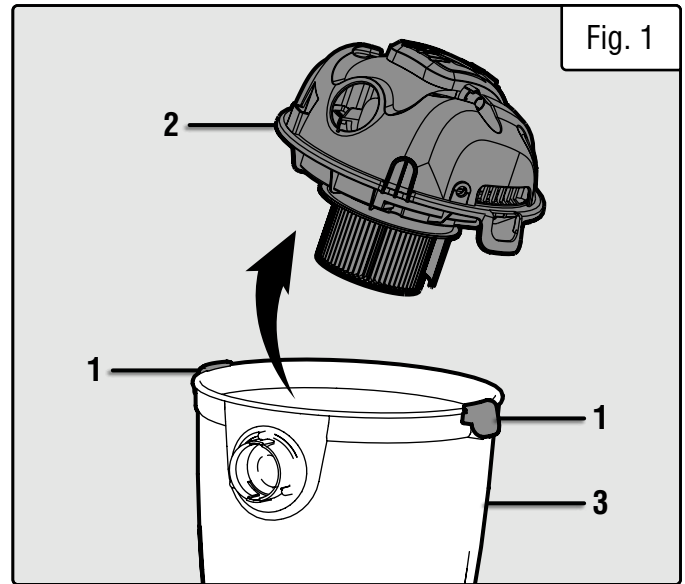

## ASSEMBLY & ADJUSTMENTS

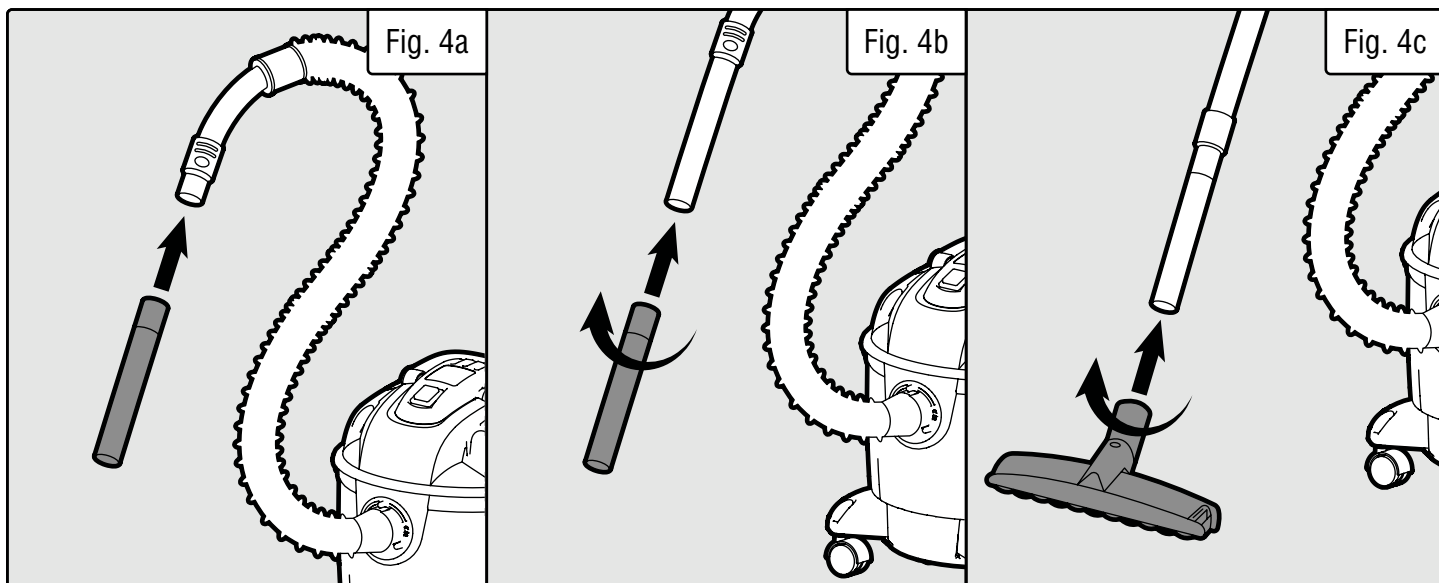

## OPERATION

### OPERATING THE VACUUM

1. The vacuum can be operated by turning on the switch (Fig. 5 - 1).
2. Airflow can be adjusted using the tab on the hose (Fig. 6 - 1) to allow for maximum airflow when necessary and lesser airflow in more delicate situations.
3. Ensure that the HEPA filter is installed during operation of the unit.

**NOTE:** To install or remove the HEPA filter, refer to p. 12.

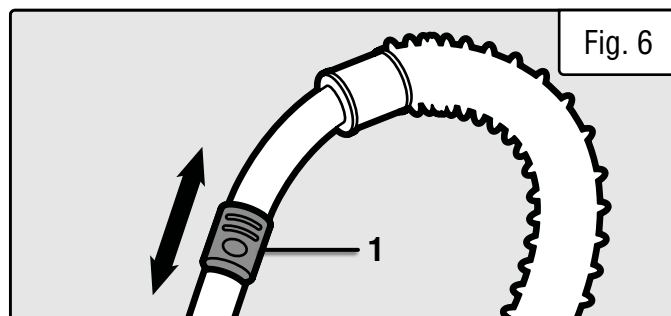
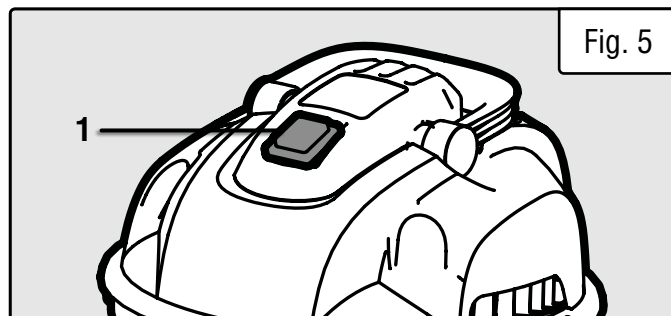

## MAINTENANCE

### REMOVING AND CLEANING DRY WASTE

**⚠ CAUTION!** Always wear ANSI Z87.1-approved eye protection, as well as a NIOSH-approved respirator or dust mask, when cleaning out the bucket or changing the filter. It is recommended to work outside, in an area with sufficient air flow, when cleaning out the bucket or changing the filter.

1. Unplug the unit from the power source.
2. Remove the top vacuum cover and dispose of any waste found in the bucket.
3. If the vacuum has shown a decrease in suction, it might be due to a clogged HEPA filter.
  - a. To clean the filter, remove the top vacuum cover (Fig. 7 - 1) and unscrew the lock knob (Fig. 7 - 2) to release the HEPA filter.
  - b. Tap the filter against the inside of a garbage can to remove large particles of debris.
  - c. Use compressed air, or water from a garden hose, to remove fine particles from the filter.

**NOTE:** Direct the compressed air or water outwards, spraying from the inside of the filter towards the outside, as this will produce the best results.

- d. If using a garden hose, air dry the HEPA filter until it is completely dry.
- e. Re-install HEPA filter on the top vacuum cover and secure it with the lock knob before operating the vacuum.

**NOTE:** Ensure all parts are completely dry before using the vacuum for dry waste collection.

**NOTE:** After a while, depending on how heavily and frequently the vacuum is used, the HEPA filter will not be able to be cleaned sufficiently to provide continued effective performance, and a new HEPA filter will need to be purchased. Replacement HEPA filters can be found at [wenproducts.com](http://wenproducts.com) under item number VC4710-038.

### REMOVING AND CLEANING WET WASTE

1. Unplug the unit from the power source.
2. Pour the wet waste into a suitable drain.
3. Plug the unit back in to continue operation.

**NOTE:** For both wet and dry jobs, it is suggested to occasionally rinse the bucket with clean water to rid the vacuum of any unwanted particles or critters, as well as to keep the vacuum fresh and its morale high. After all, its job quite literally sucks.

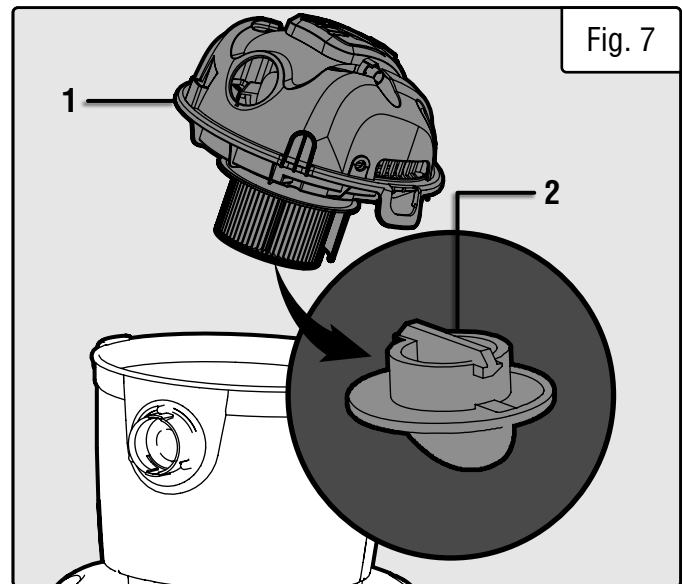

## TROUBLESHOOTING GUIDE

**WARNING!** Stop using the generator immediately if any of the following problems occur or risk serious personal injury. If you have any questions, please contact customer service at **1-800-232-1195** (M-F 8-5 CST), or email [techsupport@wenproducts.com](mailto:techsupport@wenproducts.com).

Problem	Cause	Solution
<b>Vacuum cleaner will not turn on</b>	Plug is not connected to outlet.	Check the power cord and plug. Do not use the unit if there is damage to the cord.
	Using wrong size or length of extension cord.	Consult chart on p. 7. Use the proper extension cord.
	Worn carbon brushes.	Replace carbon brushes. Contact customer service at <b>1-(800)-232-1195</b> , M-F 8-5 CST for assistance.
	Power switch or motor is defective.	Stop using the tool and contact customer service at <b>1-(800)-232-1195</b> , M-F 8-5 CST for assistance.
<b>Dust is ejected from the exhaust port</b>	Filter is not installed or installed improperly.	Check filter installation and install properly.
	Filter is damaged.	Replace the filter with a new filter.
<b>Vacuum shows loss of suction</b>	Hose is connected to blower outlet.	Connect hose to suction inlet.
	Filter is clogged.	Clean or replace the filter.
	Vacuum bucket is full.	Empty waste from bucket.
	The hose connection is loose.	Check hose connections and tighten any loose attachments.
	Top cover is improperly sealed on the collector bucket.	Check seal. Make sure cover is securely seated on collector bucket.
	Damage to hose.	Replace the hose.

# EXPLODED VIEW & PARTS LIST

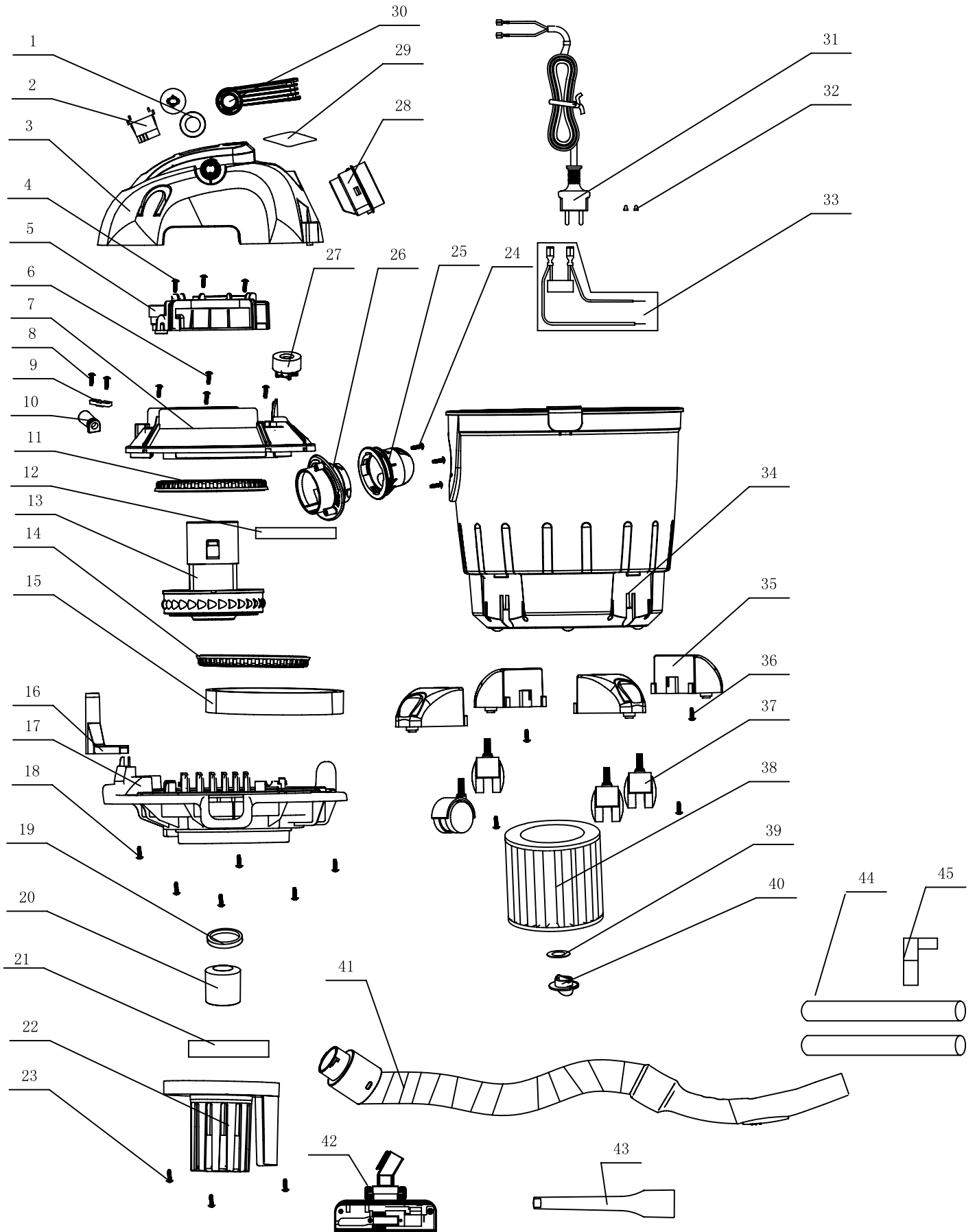

## **EXPLODED VIEW & PARTS LIST**

No.	Part No.	Description	Qty.
1	VC4710-001	Handle Cap	2
2	VC4710-002	Switch	1
3	VC4710-003	Top Cover	1
4	VC4710-004	ST3.9x16 Screw	3
5	VC4710-005	Motor Cover	1
6	VC4710-006	ST3.9x16 Screw	4
7	VC4710-007	Upper Motor Cover	1
8	VC4710-008	ST3.9x14 Motor Screw	2
9	VC4710-009	Cord Clip	1
10	VC4710-010	Cord Stress Relief	1
11	VC4710-011	Motor Outlet Seal	1
12	VC4710-012	Cooling Hood Seal	1
13	VC4710-013	Motor	1
14	VC4710-014	Motor Isolation Seal	1
15	VC4710-015	Noise Reduction Foam	1
16	VC4710-016	Intake Pipe	1
17	VC4710-017	Lower Motor Cover	1
18	VC4710-018	ST3.9x20 Screw	6
19	VC4710-019	Float Seal	1
20	VC4710-020	Float	1
21	VC4710-021	HEPA Shelf Sealing Patch	1
22	VC4710-022	HEPA Frame	1

No.	Part No.	Description	Qty.
23	VC4710-023	ST3.9x14 Screw	3
24	VC4710-024	ST3.9x14 Screw	3
25	VC4710-025	Suction Base Cover	1
26	VC4710-026	Suction Base	1
27	VC4710-027	Protection Valve Assembly	1
28	VC4710-028	Blower Outlet	1
30	VC4710-030	Handle	1
31	VC4710-031	Power Cord	1
32	VC4710-032	Wiring Cap	2
33	VC4710-033	Connection Assembly	1
34	VC4710-034	Vacuum Bucket	1
35	VC4710-035	Wheel Base	4
36	VC4710-036	ST3.9x14 Screw	4
37	VC4710-037	Caster	4
38	VC4710-038	HEPA Filter	1
39	VC4710-039	Ø 37 Gasket	1
40	VC4710-040	Lock Knob	1
41	VC4710-041	Hose	1
42	VC4710-042	Utility Nozzle	1
43	VC4710-043	Crevice Nozzle	1
44	VC4710-044	Extension Tube	2
45	VC4710-045	Storage Hook	1

# **WARRANTY STATEMENT**

WEN Products is committed to building tools that are dependable for years. Our warranties are consistent with this commitment and our dedication to quality.

## **LIMITED WARRANTY OF WEN PRODUCTS FOR HOME USE**

GREAT LAKES TECHNOLOGIES, LLC (“Seller”) warrants to the original purchaser only, that all WEN consumer power tools will be free from defects in material or workmanship during personal use for a period of two (2) years from date of purchase or 500 hours of use; whichever comes first. Ninety days for all WEN products if the tool is used for professional or commercial use. Purchaser has 30 days from the date of purchase to report missing or damaged parts.

SELLER’S SOLE OBLIGATION AND YOUR EXCLUSIVE REMEDY under this Limited Warranty and, to the extent permitted by law, any warranty or condition implied by law, shall be the replacement of parts, without charge, which are defective in material or workmanship and which have not been subjected to misuse, alteration, careless handling, misrepair, abuse, neglect, normal wear and tear, improper maintenance, or other conditions adversely affecting the Product or the component of the Product, whether by accident or intentionally, by persons other than Seller. To make a claim under this Limited Warranty, you must make sure to keep a copy of your proof of purchase that clearly defines the Date of Purchase (month and year) and the Place of Purchase. Place of Purchase must be a direct vendor of Great Lakes Technologies, LLC. Purchasing through third party vendors, including but not limited to garage sales, pawn shops, resale shops, or any other secondhand merchant, voids the warranty included with this product. Contact [techsupport@wenproducts.com](mailto:techsupport@wenproducts.com) or 1-800-232-1195 with the following information to make arrangements: your shipping address, phone number, serial number, required part numbers, and proof of purchase. Damaged or defective parts and products may need to be sent to WEN before the replacements can be shipped out.

Upon the confirmation of a WEN representative, your product may qualify for repairs and service work. When returning a product for warranty service, the shipping charges must be prepaid by the purchaser. The product must be shipped in its original container (or an equivalent), properly packed to withstand the hazards of shipment. The product must be fully insured with a copy of the proof of purchase enclosed. There must also be a description of the problem in order to help our repairs department diagnose and fix the issue. Repairs will be made and the product will be returned and shipped back to the purchaser at no charge for addresses within the contiguous United States.

THIS LIMITED WARRANTY DOES NOT APPLY TO ITEMS THAT WEAR OUT FROM REGULAR USAGE OVER TIME, INCLUDING BELTS, BRUSHES, BLADES, BATTERIES, ETC. ANY IMPLIED WARRANTIES SHALL BE LIMITED IN DURATION TO TWO (2) YEARS FROM DATE OF PURCHASE. SOME STATES IN THE U.S. AND SOME CANADIAN PROVINCES DO NOT ALLOW LIMITATIONS ON HOW LONG AN IMPLIED WARRANTY LASTS, SO THE ABOVE LIMITATION MAY NOT APPLY TO YOU.

IN NO EVENT SHALL SELLER BE LIABLE FOR ANY INCIDENTAL OR CONSEQUENTIAL DAMAGES (INCLUDING BUT NOT LIMITED TO LIABILITY FOR LOSS OF PROFITS) ARISING FROM THE SALE OR USE OF THIS PRODUCT. SOME STATES IN THE U.S. AND SOME CANADIAN PROVINCES DO NOT ALLOW THE EXCLUSION OR LIMITATION OF INCIDENTAL OR CONSEQUENTIAL DAMAGES, SO THE ABOVE LIMITATION OR EXCLUSION MAY NOT APPLY TO YOU.

THIS LIMITED WARRANTY GIVES YOU SPECIFIC LEGAL RIGHTS, AND YOU MAY ALSO HAVE OTHER RIGHTS WHICH VARY FROM STATE TO STATE IN THE U.S., PROVINCE TO PROVINCE IN CANADA AND FROM COUNTRY TO COUNTRY.

THIS LIMITED WARRANTY APPLIES ONLY TO ITEMS SOLD WITHIN THE UNITED STATES OF AMERICA, CANADA AND THE COMMONWEALTH OF PUERTO RICO. FOR WARRANTY COVERAGE WITHIN OTHER COUNTRIES, CONTACT THE WEN CUSTOMER SUPPORT LINE. FOR WARRANTY PARTS OR PRODUCTS REPAIRED UNDER WARRANTY SHIPPING TO ADDRESSES OUTSIDE OF THE CONTIGUOUS UNITED STATES, ADDITIONAL SHIPPING CHARGES MAY APPLY.



This brochure was downloaded from

# wet-dry-vac.com

The most comprehensive source of information about wet/dry shop vacuums on the Internet!

Wet-dry-vac.com allows you to learn about how to purchase a wet/dry vac, compare and review detailed specifications on hundreds of models, and find compatible filters.

You can also view manuals, parts lists and brochures for hundreds of models. Plus, you can find the best prices for vacuums and filters, and purchase online right from the site.

