

VEVOR[®]

**WET&DRY VACUUM CLEANER
INSTRUCTION MANUAL**

VEVOR[®]

WET&DRY VACUUM CLEANER

YLW6222

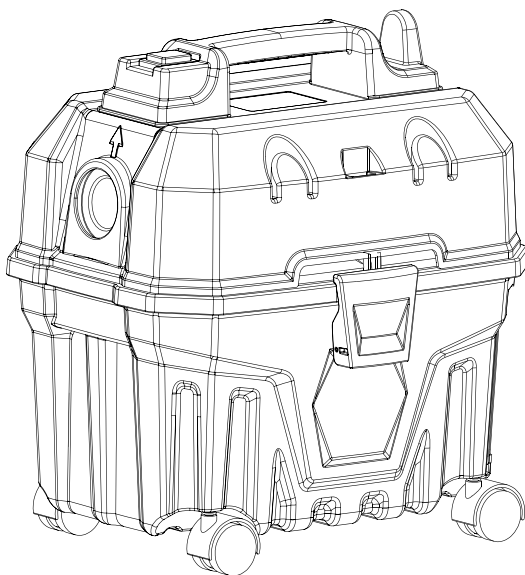

Please read the instruction manual carefully before operation.
Keep this manual safely.

NEED HELP? CONTACT US!

Have product questions? Need technical support? Please feel free to contact us:

CustomerService@vevor.com

This is the original instructions, please read all manual instructions carefully before operating. VEVOR reserves clear interpretation of our user manual. The appearance of the product shall be subject to the product you received. Please forgive us that we won't inform you again if there is any technology or software updates on our product.

SAFETY DIRECTIONS

IMPORTANT MESSAGE

When using an electrical appliance, basic precaution should always be followed including the following:

READ ALL INSTRUCTION BEFORE USING THIS VACUUM CLEANER

WARNING

To reduce the risk of fire, electric shock, or injury:

Do not use outdoors.

Do not leave vacuum cleaner when plugged in. Turn off the switch and unplug the electrical cord when the vacuum cleaner is not in use and before servicing.

Do not allow to be used as a toy. Close attention is necessary when used by children or there are children nearby.

Use only as this manual described. Use only manufacturer's recommended attachments.

Do not use with damaged power cord or plug.

Do not pull or carry by the cord, use the cord as a handle, twist or pull the cord around sharp edges and corners. Do not run this vacuum over cord. Keep the cord away from heated surface.

Do not use extension cords or outlets with inadequate current carrying capacity. Turn off all controls before unplugging.

Do not unplug by pulling on cord. To unplug, grasp the plug, not the cord.

Do not handle plug or vacuum cleaner with wet hands or operate without shoes.

Do not put any object into openings. Do not use with the opening blocked. Keep the hose free of dust, lint, hair, and anything that may reduce airflow.

This vacuum cleaner creates suction and contains a revolving brush roll. Keep your hair, loose clothes, fingers, and other part of body away from the openings and moving parts of the vacuum cleaner. Do not pick up anything that is burning or smoking, such as cigarettes, matches or hot ashes.

Do not use without dust cup or filter in place.

Use extra care when cleaning on stair.

Do not use to pick up flammable or combustible liquids such as gasoline, or use in areas where they may be present.

Store your cleaner indoors in a cool, dry area.

Ensure you turn the unit off at the very minimum every 15 minutes (for 1 minute) to let the motor cool down. Failure to do so may bring damage to motor.

Do not use this unit for more than 4 hours (including breaks) on any given day.

PARTS NAME

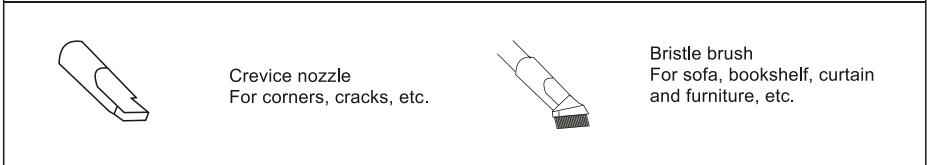
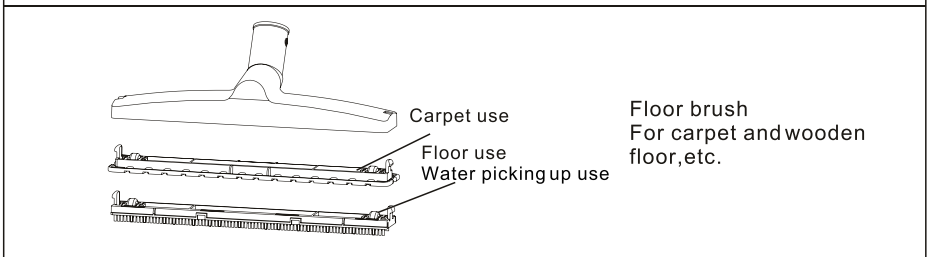
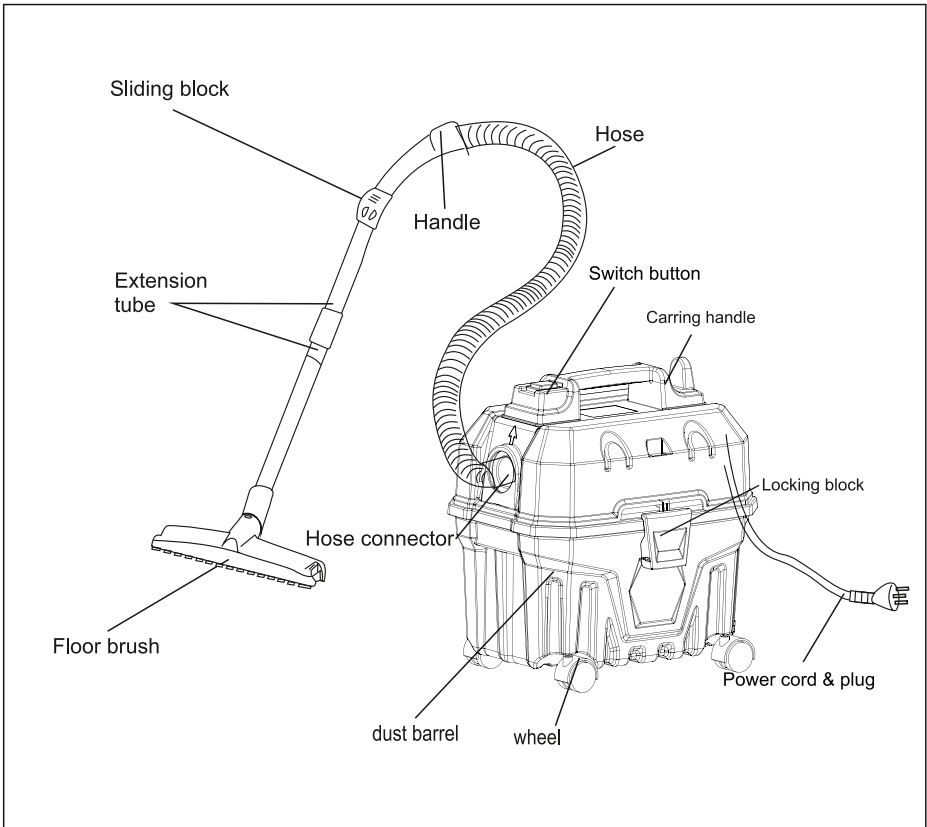

OPERATION METHOD

1

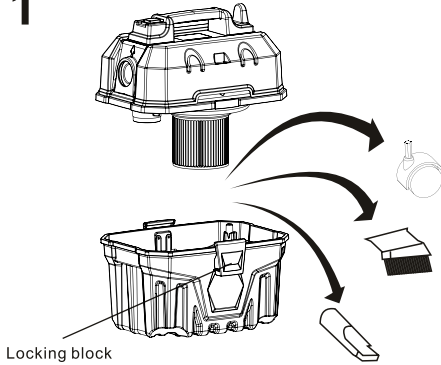

Release the lock block to open the Upper housing, then take out wheels and other accessories.

2

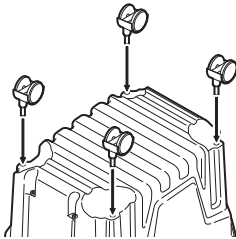

1.Install castor wheels into the hole on the base.
2.Install accessories basket into the base and fix it with 4 pcs screws as image.(The screw is packed by small polybag and then put into the tank)

3

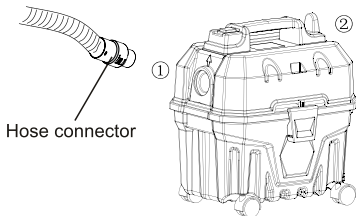

Put the hose connector into ①,the suction function is available
Put the hose connector into ②,the blow function is available

OPERATION METHOD

1

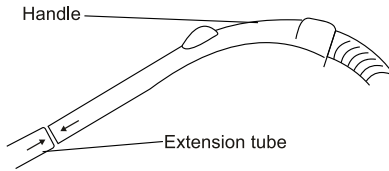

Insert the handle into the tube with a twisting force.

2

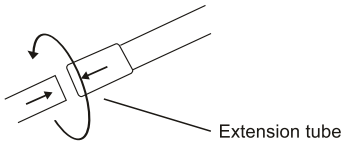

Same as the picture one.

3

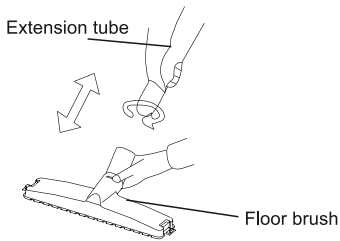

Same as picture one.

4

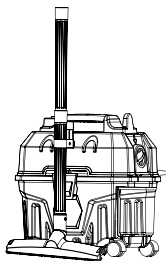

Dual storage for accessories

OPERATION METHOD

1

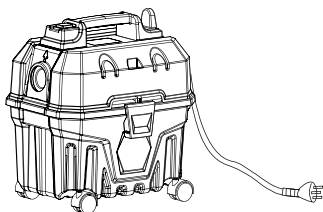

Hold the plug and insert into socket

2

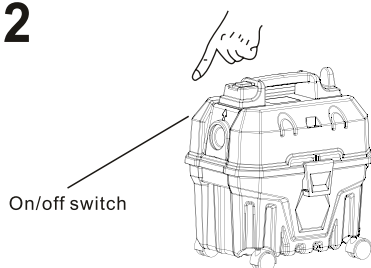

On/off switch

Press the switch button to turn on/off the cleaner

To be safe, there is a water-proof switch cover. Please replace a water-proof cover once find it broken.

3

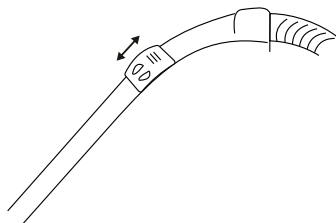

You can adjust the airflow by push the sliding block up and down.

TO REPLACE DUST BAG

If the dust barrel is full, please empty it as soon as possible

1

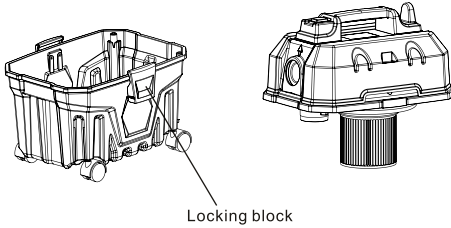

Release the lock block to open the upper housing

2

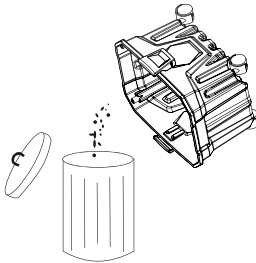

Empty the dust barrel

3

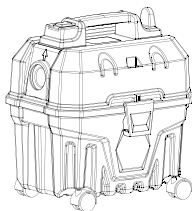

Put back the upper housing,
fasten the locking panel

MAINTENANCE

Warning: When the filters are obviously covered with dust or the suction decreases considerably, please clean it in time, for this can improve the working efficiency and extend the life time of the cleaner.
Never use the machine without filters.

1

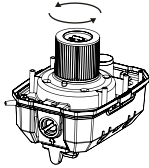

Twist the locking knob with a anti-clockwise fore to take off the filter.

2



Clean it carefully

3

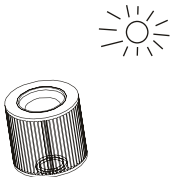

Air dry

4

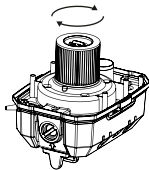

Put back the filter.

E-mail: CustomerService@vevor.com

Manufacturer: Zhejiang Yili Machinery And Electric Co., Ltd.

Add: No.111 Lingxiu Road, Luoxing Street, Jiashan County, JIAXING CITY, Zhejiang Province 314100

Made in China

VEVOR[®]

E-mail: CustomerService@vevor.com

This manual was downloaded from

wet-dry-vac.com

The most comprehensive source of information about wet/dry shop vacuums on the Internet!

Wet-dry-vac.com allows you to learn about how to purchase a wet/dry vac, compare and review detailed specifications on hundreds of models, and find compatible filters.

You can also view manuals, parts lists and brochures for hundreds of models. Plus, you can find the best prices for vacuums and filters, and purchase online right from the site.

